

## Type G31 Seeflex

The Seetru Seeflex Gauge is designed for use within the marine & offshore industries for tanks containing flammable liquids. The Seeflex gauge meets the requirements of SOLAS (Safety of Lives at Sea). This gauge is commonly used on cargo ships and work boats.

### Example Applications

- Diesel
- Fuel oil
- Aviation fuel
- Lubrication oil
- Water
- Coolant

### Specifications

- Maximum Operating Pressure: 2.67 bar
- Maximum Operating Temperature: 80°C
- Minimum Operating Temperature: -35°C
- Minimum Centre Distance – Closed Circuit Design: 358mm
- Minimum Centre Distance – Open Circuit Design: 315mm

### Materials of Construction

Component	Material
Front Bezel	Black Coated, Rust Protected Mild Steel
	Stainless Steel 304
Back Channel	Stainless Steel 304
Valve Bodies / End Units	Brass
	Stainless Steel 316
Reflex Glass	Hardened Borosilicate

### Seal Materials

O-ring material – Top cap	Temperature Range
Nitrile (NBR)	-35°C to +80°C

Other seal materials available upon request.



### Approvals

- Det Norske Veritas (DNVGL),
- Lloyds Register of Shipping (LR)
- Russian Maritime Register of Shipping (RMRS)
- Russian River Register (RRR)
- American Bureau of Shipping (ABS)
- Bureau Veritas (BV)
- RINA
- Nippon Kaiji Kyokai (Class NK)

\*Meets the requirements of SOLAS (Safety of Lives at Sea)\*

### Connection Options

Type	Size
Weld Bosses	42mm Weld Boss
Threaded Connections	G1/2" BSP male
	G3/4" BSP male
Flanged Connections	DN20 PN16
	DN25 PN16
	3/4" ANSI 150
	1" ANSI 150
Non-Weld Boss	42mm

Other connections available upon request.



Gauge always supplied with Push-button Isolation Valve at the bottom connection

### With 42mm Weld Bosses

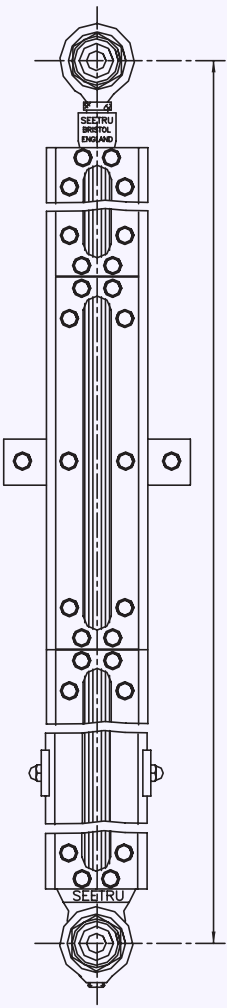

### With Flanged Connections

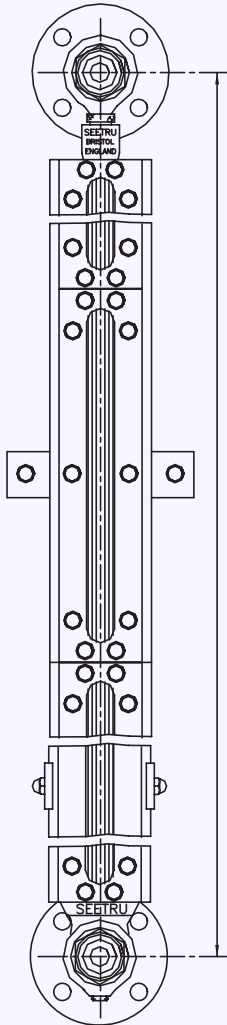

### Closed Circuit Design Top Fittings

Self Closing Pushbutton Isolation Valve

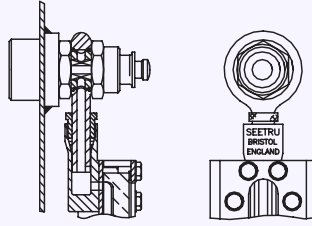

### Closed Circuit Design

(Top Of Gauge Must Be Min. 100mm Above Tank Top) Automatic Safety Vent Valve

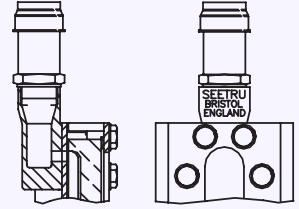

### Valveless Tank Return

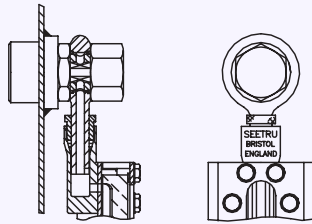

### Pipe Union Connection

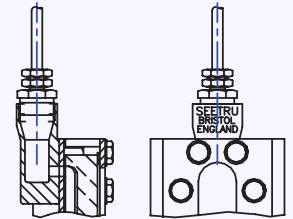

### Connection Options

#### Threaded Connection

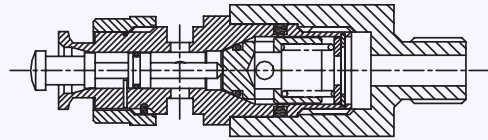

#### 42mm Weld Boss Connection

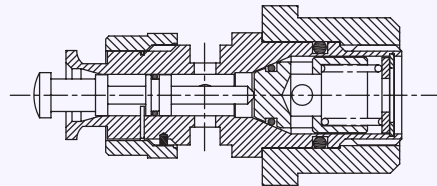

#### Non-Weld Boss Connection

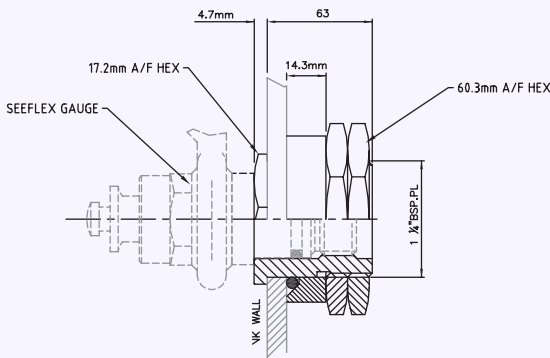

The tank boss is only suitable for use with tanks of wall thickness from 1.58mm (1/16") to 7.9mm (5/16") hole diameter of 42.0mm is required in the tank wall.

#### Flanged Connection

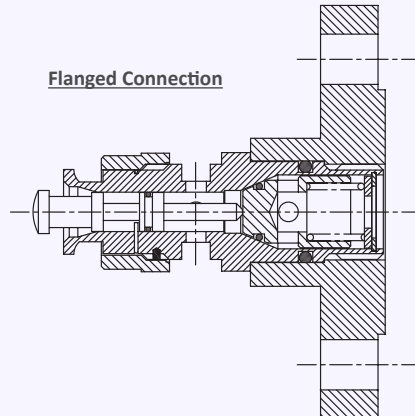



## HYDRAULIC ACTUATION

The hydraulic actuation allows the operation of more than one valve from the same location, In the case of the integral system, both valves will be mounted on the same gauge- this is used mainly for longer gauges that exceed 1000mm centres. The remote system allows the operation of up to 4 valves on various gauges from the same location.

### Integrated Hydraulic Actuation

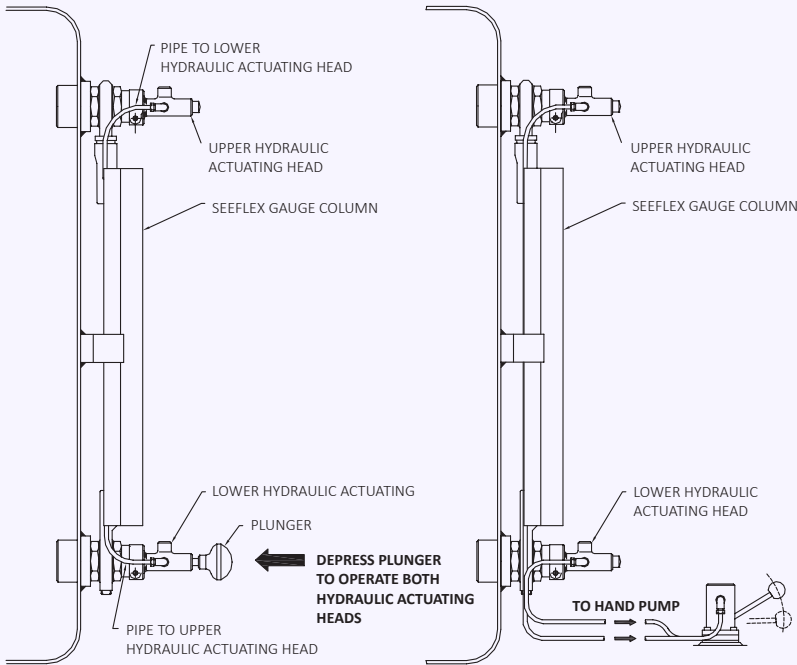

### Remote Hydraulic Actuation

#### Push-button operation

Except when a reading is being taken, the gauge is permanently isolated from the contents of the tank. To take a reading the spring-loaded valve is opened by pressing a Push-button. When released, the connection between the tank and gauge is automatically resealed.

#### Safe from external damage

Due to the design of the push-button isolation valve, no amount of damage to the gauge or external fittings on the tanks can break the liquid seals. In such an event the fluids cannot escape.

#### Closed circuit design

The closed circuit design penetrates the tank wall at both top and bottom connections. The options for the top connection are either a push-button self-closing valve or valve less tank return.

#### Open circuit design

This is only allowable when it is possible for the gauge column to extend above the top of the tank by at least 100 mm. The upper end of the gauge can be supplied with an automatic safety vent valves or, alternatively, a pipe union connection. The automatic safety vent will allow air to pass, but will seal against a liquid level. In the case of the pipe union connection design, a 10 mm o/d steel vent pipe is returned to the tanks or into the tank vent pipe.

#### Graduation

Where a measure of the precise storage volume is required, an engraved scale plate can be provided marked with the capacity units.

### Column Supports

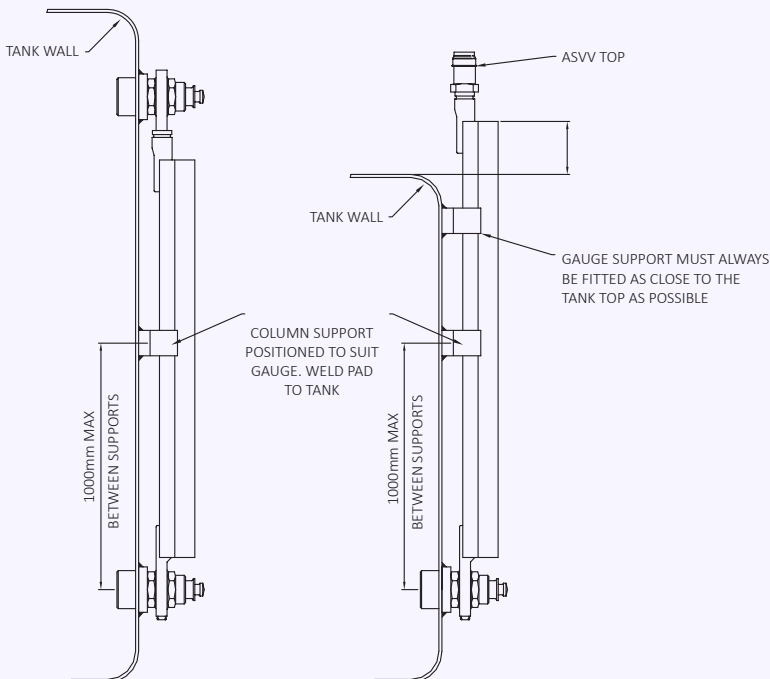

Gauges that have a centre distance greater than 1000mm and open circuit gauges, will be supplied with a column support, so that the gauge can be fixed to the tank wall. The maximum distance between the gauge fixings and a column support or between two column supports should be 1000mm, in the case of open circuit gauges the top most column support should be fitted as close to the tank top as possible.

Number of isolating valves	Total allowable length of piping
1	60 metres
2	30 metres
3	20 metres
4	15 metres