

Enclosed Discharge Safety Relief Valves

Seetru Limited

for compressed air or gases

cryogenic & liquefied gas

hydrogen

Type

94605 / 946H5 / 95605 / 956H5

Safety valves made from stainless steel <
Enclosed discharge with threaded connections <

Example Applications

- Air/Gas Compression
- Air/Gas Boosters
- Natural Gas
- Pressure Vessels
- Hydrogen Production
- Hydrogen Storage

Specifications

- **Inlet Connections**
 - 1/2" NPT, BSP & BSPT
 - 9/16" Cone & Thread
 - 3/4" Cone & Thread
- **Outlet Connections**
 - 1/2" NPT & BSP
 - 3/4" NPT & BSP
 - 1" NPT & BSP
- **Temperature Range**
 - 0° to 300°C as standard
 - -196°C to 300°C H₂ option
- **Pressure Range**
 - 35.0 to 515 bar (9*605)
 - 35.0 to 1100 bar (9*6H5)

*Maximum set pressure for steam is 85 bar

Materials of Construction

Component	Valve Type 2nd Digit	Material	Grade
Seat	4	Stainless	1.4057
	5		S20910
Body	4 & 5	Stainless	1.4401
Disc	4	Stainless	1.4057
	5	Ceramic	
Spring	4 & 5	Stainless	1.4401
Gaskets	4 & 5	PTFE	

For Hydrogen applications above 515 bar, a ceramic disc is required, use type 956H5

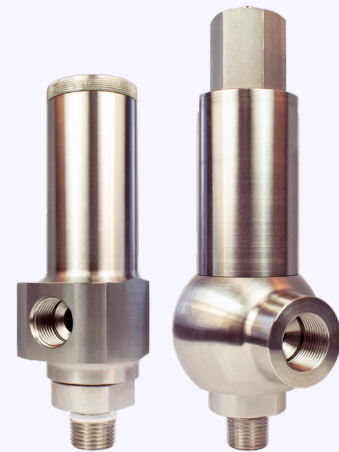

Key Features

- Compact and space saving design
- Designed and built for repeatable operation
- Advanced sealing technology with super-lapped hard-faced seat and disc, designed to offer robust high-performance sealing
- Orientable gas-tight packed lever option (9*6H5 only)
- Simple and robust design with three moving parts
- Maintenance friendly design
- All wrought construction with no castings
- Designed with Hydrogen embrittlement resistant materials (H₂ option)

Approvals

- BS EN ISO 4126-1
 - PED 2014/68/EU
 - Module B – TÜV Rheinland
 - Module D – LRQA Deutschland
 - PE(S)R 2016 (UKCA)
 - Module B – TÜV UK
 - Module D – LRQA UK
 - Seat tightness better than API 527
- EAC marking available upon request

Top Fitting Options

- Sealed Cap (gas tight cap)
- Sealed lever (gas tight)

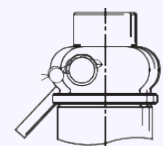
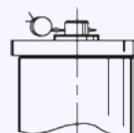

Technical information by bore size

Model No.	9*605			9*6H5	
Bore	4.6mm				
Inlet	1/2"	9/16"	1/2"	9/16"	3/4"
Outlet	1/2"		1/2"	3/4"	1"
Flow Area	16.6 mm ²				
Height H	158			202	
Kdr	0.75				
Weight	1.5 kg			2.8 kg	

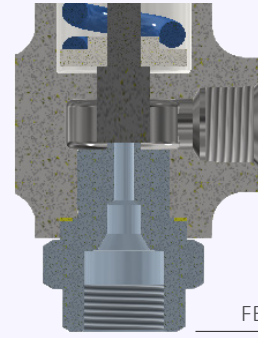

FEMALE CONE & THREAD INLET

Standard INLET Connection Types

- BSP (male) max 515 bar
- BSPT (male) max 515 bar
- NPT (male) max 1034 bar
- Cone & Thread (female) max 1100 bar

Standard OUTLET Connection Types

- BSP (female)
- NPT (female)

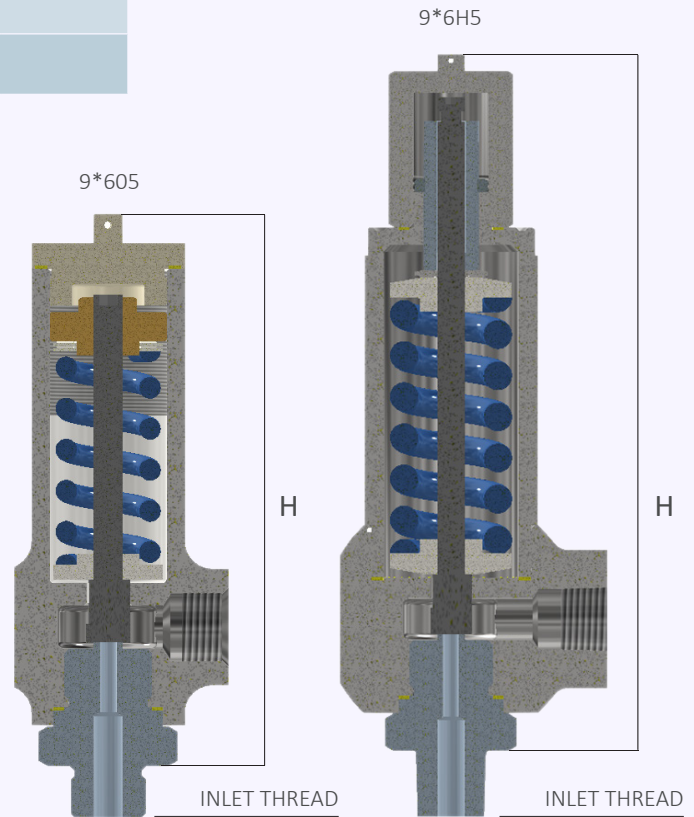

Please send your selected details to Seetru and we can provide the full ordering code, price and lead-time.

Valve Selection Guide - Type 94605, 946H5, 95605 & 956H5

Valve type	H ₂ or low temperature valve type 2 nd digit		Inlet Size	Inlet Connection	Outlet Size	Outlet Connection	Easing Lever (Sealed Lever)
	Yes	No					
9*605	5	4	9/16" & 3/4"	C&T	1/2"	NPT, BSP	9*6H5 only
9*6H5			1/2"	NPT, BSP, BSPT			
			1/2"	C&T	1/2", 3/4", 1"		
			9/16" & 3/4"				

Example of Valve Selection Process for Order Code 956H5F1297

Example Selection	Approval	Materials from above Table	Bore	Inlet Size	Inlet Thread	Outlet Size	Outlet Thread	Duty	Set Pressure
	PED and UKCA (ASME in process)	5 = Body=1.4401, Seat=S20910, Disc=Ceramic	4.6mm	1/2"	NPT	3/4"	NPT	Hydrogen	1000 bar

Capacity Table -Per EN 4126-7 and at 10% Overpressure

Type 94605 / 946H5 / 95605 / 956H5: Flow rates at 10% above the set pressure.



Set Pressure 		Flow of Air
bar	psi	Nm ³ /hr
35	507.5	335.5
50	725	475.5
75	1087.5	709.0
100	1450	942.5
150	2175	1409.4
200	2900	1876.4
250	3625	2343.3
300	4350	2810.3
350	5075	3277.2
400	5800	3744.2
450	6525	4211.1
500	7250	4678.1
550	7975	5145.1
600	8700	5612.0
650	9425	6078.9
700	10150	6545.9
750	10875	7012.8
800	11600	7479.8
850	12325	7946.7
900	13050	8413.7
950	13775	8880.6
1000	14500	9347.6
1050	15225	9814.5
1100	15950	10281.5

Set Pressure 		Flow of Hydrogen
bar	psi	Nm ³ /hr
35	507.5	1273.2
50	725	1804.9
75	1087.5	2691.1
100	1450	3577.2
150	2175	5349.5
200	2900	7121.8
250	3625	8894.1
300	4350	10666.3
350	5075	12438.6
400	5800	14210.9
450	6525	15983.3
500	7250	17755.5
550	7975	19527.8
600	8700	21300.1
650	9425	23072.4
700	10150	24844.7
750	10875	26617.1
800	11600	28389.2
850	12325	30161.5
900	13050	31933.8
950	13775	33706.1
1000	14500	35478.5
1050	15225	37250.7
1100	15950	39023.0